





**bticino**

進口總代理



巨特企業股份有限公司

TRENTECH ENTERPRISE CO., LTD.

台北市和平東路二段 257 號 9 樓

9F., 257, HO-PIN E. RD. SEC.2, TAIPEI, TAIWAN, R.O.C.

TEL : (02)2784-0206 FAX : (02)2702-8960





**b**ticino



## LIVINGLIGHT











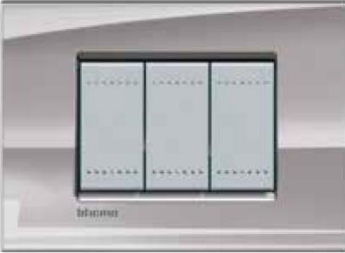
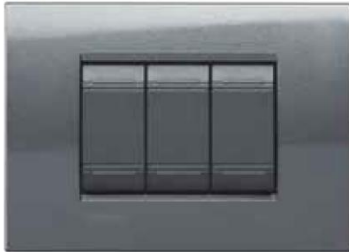

Un solo nome per infinite soluzioni

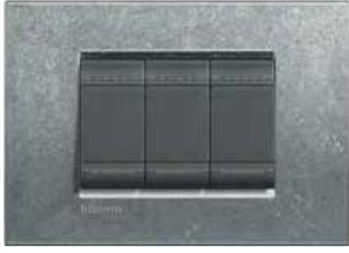

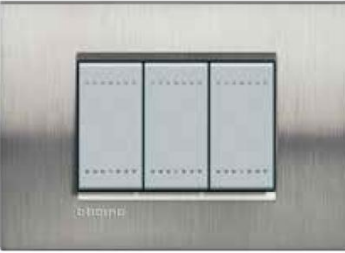







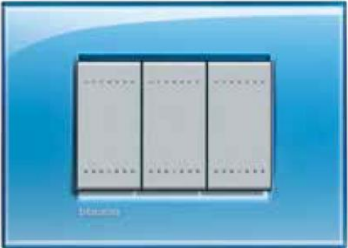

### I VANTAGGI DELL'OFFERTA

Una raffinata combinazione di forme, colori, materiali e superfici per soddisfare ogni tipo di gusto estetico: dal minimal al sofisticato, dal tradizionale all'esibito. Design e tecnologia si incontrano nella forma perfetta di AIR che, con uno spessore inferiore a 5 mm, è una innovazione assoluta LIVINGLIGHT.

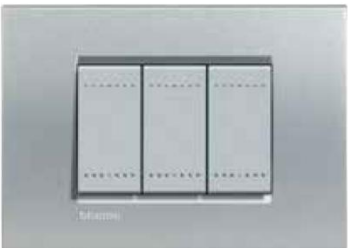

LIVINGLIGHT  
Finitura placche quadre

<b>METALS</b> Materiale: zama	 <p>Oro freddo - OA</p>	 <p>Bronzo - BZ</p>	 <p>Nichel - NS</p>		
	 <p>Acciaio - AC</p>	 <p>Argento lunare - GL</p>			
	<b>NATURALIA</b> Materiale: zama	 <p>Native - NA</p>	 <p>Argento - AG</p>	 <p>Acciaio spazzolato - ACS</p>	
		<b>SILK</b> Materiale: zama	 <p>Park - PK</p>	 <p>Square - SQ</p>	 <p>Brick - RK</p>
			 <p>Avenue - AE</p>	 <p>Club - CB</p>	<p><b>CODICI PLACCHE LIVINGLIGHT QUADRE</b>            2 moduli - LNA4802...            2 moduli - LNA4819*...            3 moduli - LNA4803...            4 moduli - LNA4804...            7 moduli - LNA4807...            3+3 moduli - LNA4826...</p> <p>* 2 moduli centrati per scatola            500, 502E, 503E, PB503N, PB502N</p>

<b>DEEP</b> Materiale: tecnopolimero	 Verde - VD	 Arancio - OD	 Azzurro - AD
<b>KRISTALL</b> Materiale: tecnopolimero	 Fumo di Londra - KF	 Acquamarina - KA	 Grigio ghiaccio - KG
<b>NEUTRI</b> Materiale: tecnopolimero	 Antracite - AR	 Bianco - BI	 Tech - TE
<b>ESSENZE</b> Materiale: legno massello	 Ciliegio americano - LCA	 Bambù - LBA	 Noce nazionale - LNC



# LIVINGLIGHT AIR

Finitura placche

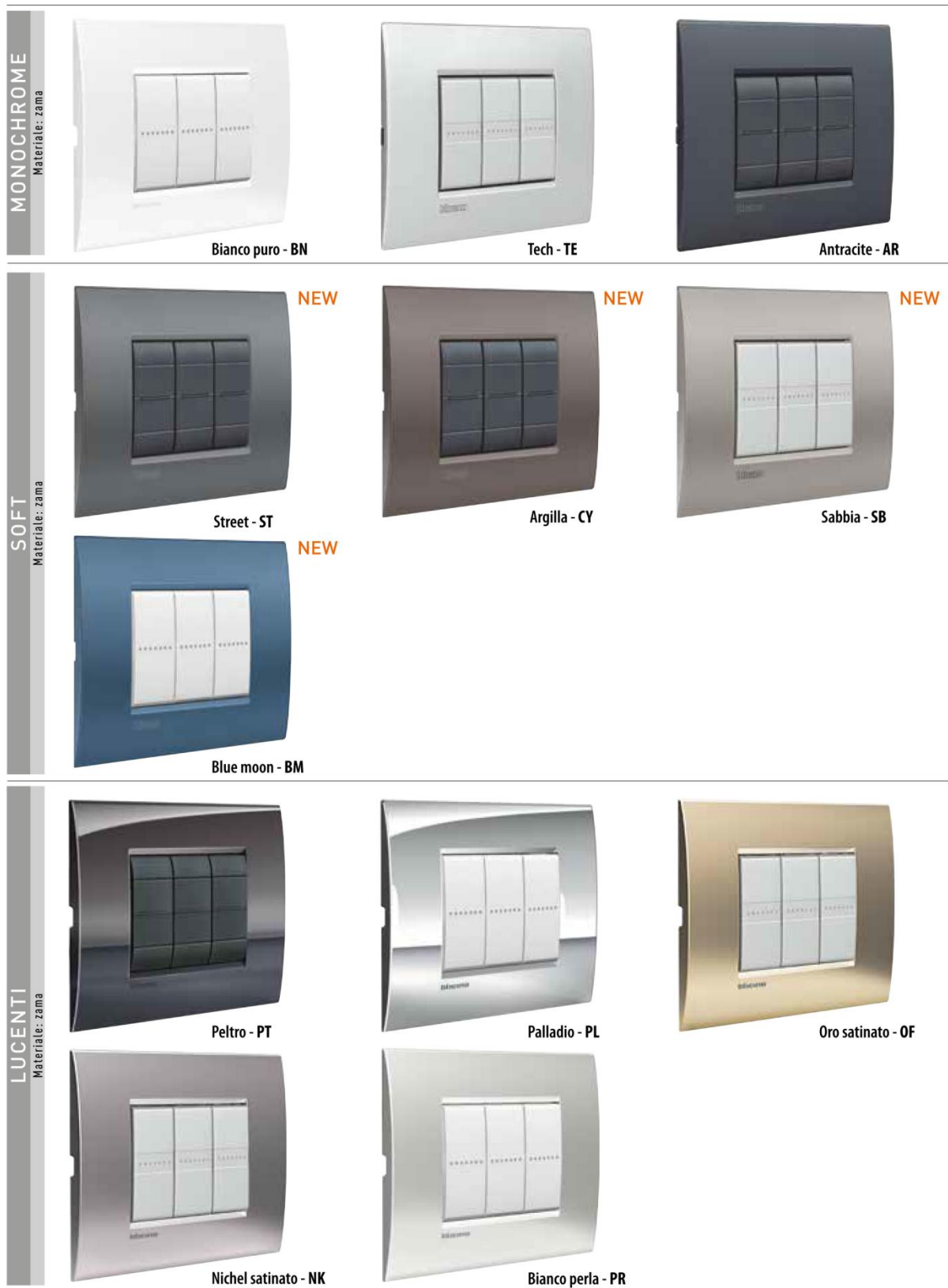

LIVINGLIGHT AIR  
Finitura placche



# AIR





## 3 module standard area



2 MODULES



3 MODULES



4 MODULES

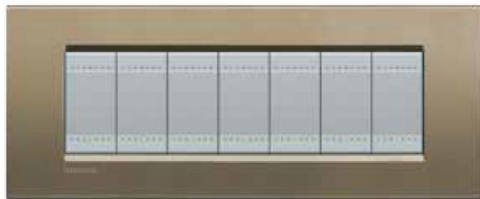

7 MODULES



3 + 3 MODULES

### FOR PROTECTED BOX

### FOR MASONRY WALLS

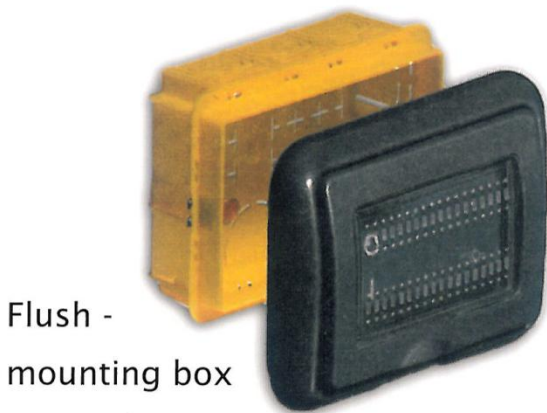

Flush -  
mounting box

Protection  
cover

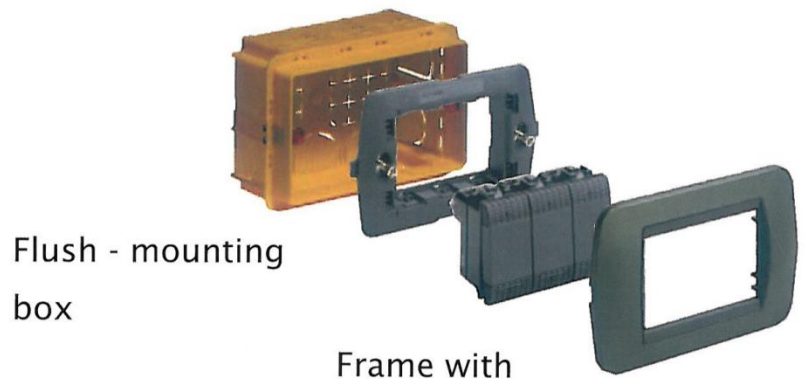

Flush - mounting  
box

Frame with  
devices

Front  
cover plate

### FLUSH-MOUNTING BOXES



503E  
(108x74x53.5 mm)

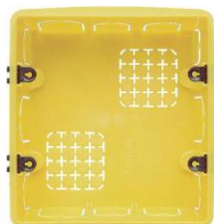

506E  
(108x118x51.5 mm)



504E  
(133x74x53.5 mm)



506L  
(183.5x90x53.5 mm)

# LIGHT LIVING / modular system

## CONTRLO AND AUTOMATION

---



L4003/220



L4005/0



N4915N



N4915M2N



N4915M3N



L4915N



L4915M2N



L4915M3N



N4037



N4373H



N4408N



N4581



N4269F

## SOCKETS AND CONNECTORS

---



N4188S



N4129S



N4127



N4128S



N4185S



N4258/11N



N4279C5E  
N4279C6



N4950



N4951



N4285C1



N4285C2



L4382/230

**bticino**



## AXOLUTE

### I VANTAGGI DELL'OFFERTA

AXOLUTE è la scelta migliore per gli ambienti di pregio: estetica ricercata e tecnologia MyHOME, valorizzano l'impianto elettrico come mai prima d'ora.



Monochrome



Anodized



Aluminium



Stone



Woods



Lacquered



Glass



Nighter & Whice

Metallized



Liquid

Leather



White

Glossy



Wood

## SWAROVSKI

The cover plates made using Swarovski Elements, of high value, are fully handmade. They are made to special request.

MADE WITH  
SWAROVSKI  
ELEMENTS

AXOLUTE  
Swarovski  
crystal



AXOLUTE  
Swarovski  
light peach

















The brightness of Swarovski Elements crystals to dress and enhance the switch with a unique and unmistakable style

Available in the following modular constructions: 2, 3, 4 and 3+3 modules.

**AXOLUTE**













Finitura placche rettangolari

MONOCHROME				
	Bianco AXOLUTE - HD	Tech - HC	Antracite - HS	
ALLUMINIO				
	Alluminio spazzolato - XC	Antracite spazzolata - XS	Titanio spazzolato - NX	
LACCATI				
	Bianco Limoges - BG	Rosso China - RC	Blu Meissen - BM	Verde Sèvres - VS
ANODIZZATI				
	Cromo - CR	Bronzo - BR	Mercurio - AZ	
				
	Argento - SAN			

**CODICE PLACCA \***  
 2 moduli - HA4802...  
 3 moduli - HA4803...  
 4 moduli - HA4804...  
 6 moduli - HA4806...  
 3+3 moduli - HA4826...

\* Vedi pagina dedicata all'installazione di AXOLUTE per dettagli

Finitura placche rettangolari in materiali pregiati

LEGNI			
	Frassino - LFR	Teak - LTK	Wenge - LWE
VETRI			
	Vetro nero notte - VNN	Vetro azzurro sera - VZS	Vetro Kristall - VKA
			
	Specchio acidato - VSA	Vetro bianco - VBB	
NIGHTER AND WHICE			
	Nighter - VNB	Whice - VSW	
PIETRE			
	Ardesia - RLV	Marmo Carrara - RMC	

**NOTA PER LE PLACCHE IN LEGNO E PIETRA:**  
 queste placche sono realizzate con materiali 100% naturali, si potrebbero pertanto verificare piccole differenze di tonalità o venatura tra una placca e l'altra. Le fotografie hanno quindi carattere indicativo.

# POP-UP BOXES



02|03

Our sleek new ergonomically designed pop-up boxes provide real ease of use and rapid connection solutions for mobile applications such as PCs, mobile phones, audio and video systems. Users have a choice of high and low current desk or floor-mounted (raised access or concrete floors) connections for immediate use.



**SLEEK DESIGN**  
Extra-slim format to blend discreetly into the office furniture or floor



**ELEGANT FINISHES**  
Aluminium, bronze, stainless steel, black or white - a perfect match for furniture and decor (p.10)



**SAFETY AND EASE OF USE**  
Soft opening cover with damper and push & slide locking system



**FUNCTIONALITY AND FLEXIBILITY**  
Available in 3, 2x3, 4 and 2x4 modules for custom configuration or ready assembled with low and high current functions (p.10 -11)





RMC : HS4258/11N RJ 11 telephone connector

HS4279/6 RJ 45 connector cat. 6 UTP

HS4269F TV connector type F

RLV : HC4053 2 way rocker switch – 1 module

HC4950 blank plate

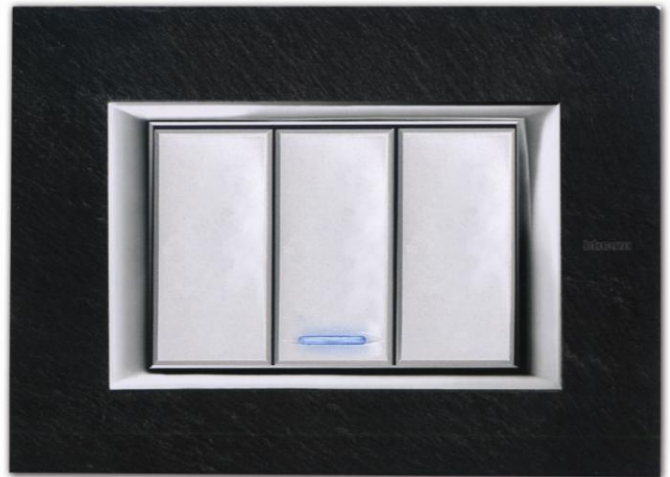

VKA : HC4053/2 2 way rocker switch – 2 modules

HC4053 2 way rocker switch – 1 module

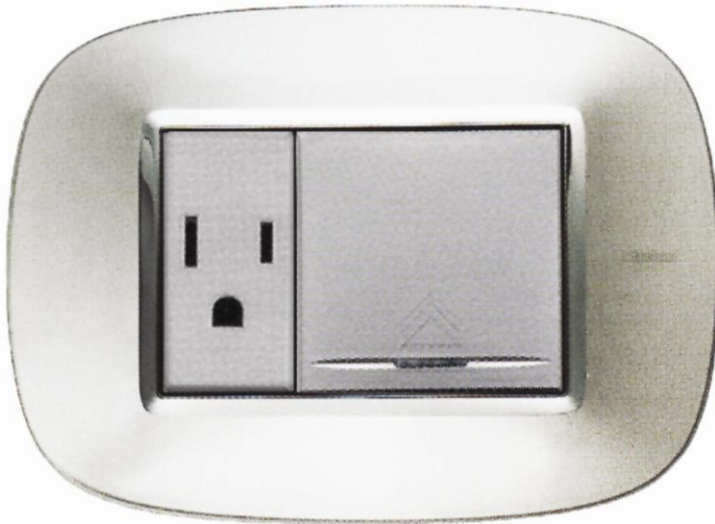

XC : HC4129S american standard socket outlet –  
1 module  
HC4582 touch dimmer



SLC : HC4188S american standard duplex  
socket outlet – 3 modules



TC : HS4053 2 way rocker switch – 1 module



- TA : N4951 blank plate with knockout  
 L4382/230 step marker lamp with white-lighted LED



- YN : N4373H double lampholder with red and green indicators for hotels -  
 "do not disturb / make up the room"  
 N4028H changeover switch for room condition indications in hotels -  
 "Please do not disturb / Please make up the room"  
 N4269F TV connector type F  
 N4581 rotary dimmer



- LB : N4279/5E RJ 45 connector cat. 5E UTP
- N4950 blank plate
- N4258/11N RJ 11 telephone connector



- TH: N4380 rechargeable pull-out emergency light

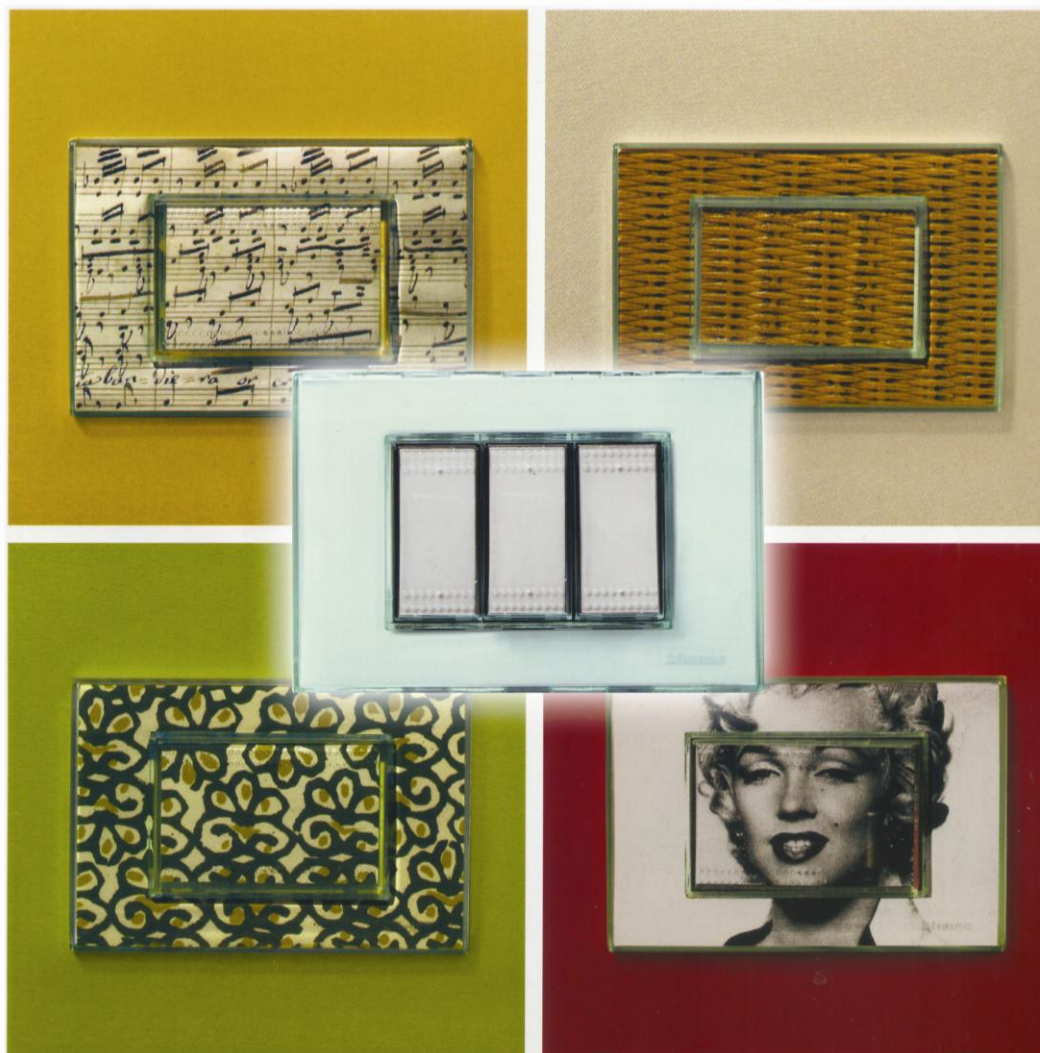

**LIGHT KRISTALL cover plate**

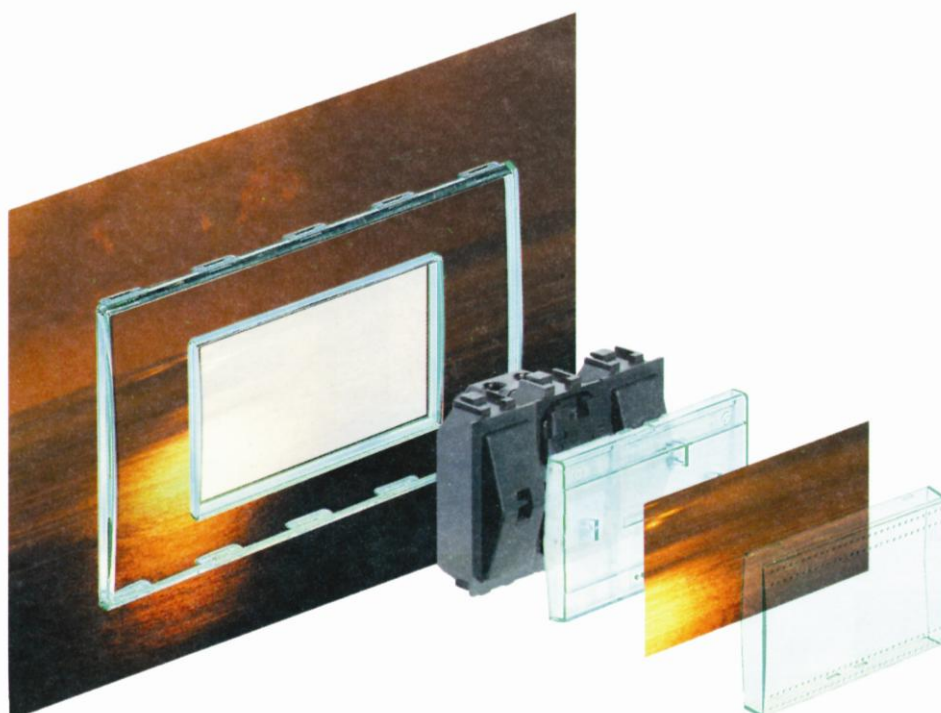

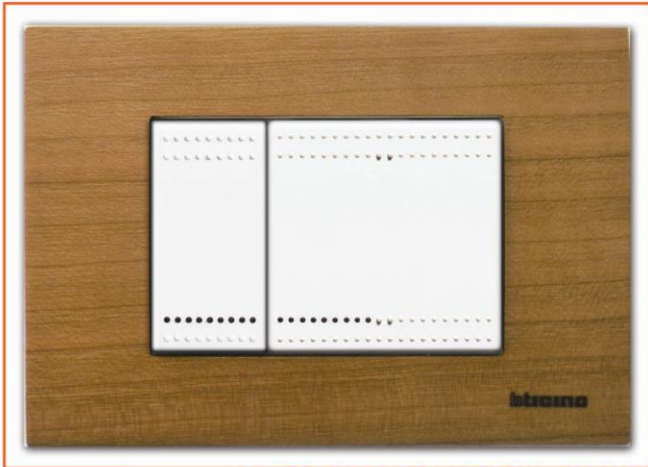

**AMERICAN CHERRYWOOD**

LCA : N4911 lightable key-cover – 1 module  
N4911/2 lightable key-cover – 2 modules



**ASH**

LFR: N4188S american standard duplex socket outlet –  
3 modules

## LIVING



**AMERICAN CHERRYWOOD**

LCA : L4911\*3 lightable key-cover – 1 module



**BRIAK**

LRN : L4911 lightable key-cover – 1 module  
L4128S american standard socket outlet – 2 modules